

# 885017

## 2436 MHz BAW Filter

### Applications

- WiFi bandpass filter that enables the coexistence of 4G (WiMAX/LTE/TD-LTE) & WiFi signals
- Handsets
- Portable Hotspots
- Mobile Routers
- Smart Meters
- High-power WLAN Access Points
- Applicable reject bands: 2.6 GHz WiMAX/LTE, 2.3GHz WiMAX/LTE, LTE Bands 7 & 38, TD-LTE Band 40, WCS, WiBro, Indian 2.3GHz 4G band

### Product Features

- Low Loss in WLAN band w/ extended upper corner for inclusion of Bluetooth
- High Rejection in 2300-2380 MHz bands: WiMAX/WCS/WiBro/Band 40/Indian 4G band
- Industry-leading small size: 1.4 x 1.2 x 0.46 mm
- +28 dBm (CW) power handling
- Performance over -30 to +85 °C
- Single-ended operation
- Ceramic chip-scale package (CSP)
- Hermetically Sealed
- RoHS compliant, Pb-free

### General Description

885017 is a high-performance, high-power Bulk Acoustic Wave (BAW) bandpass filter with extremely steep skirts, simultaneously exhibiting low loss in the WiFi band & high near-in rejection in the 2.3GHz & 2.6GHz WiMAX/LTE/TD-LTE bands.

885017 is specifically designed to enable coexistence of WiFi and WiMAX/LTE signals within the same device or in close proximity to one another.

885017 uses advanced and inexpensive packaging techniques to achieve an industry-leading 1.4 x 1.2 x 0.46 mm package. The filter exhibits excellent power handling capabilities.

885017 is referenced on multiple designs with the leading WiMAX chipset makers

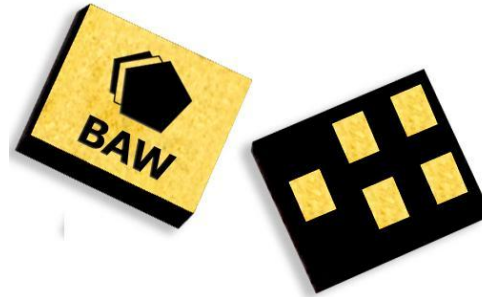

1.4 x 1.2 x 0.46 mm

### Functional Block Diagram

Top view

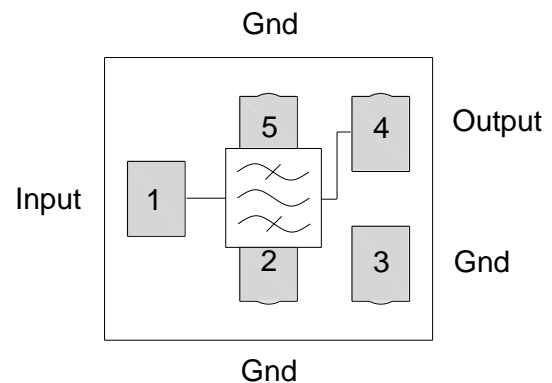

### Pin Configuration

Pin # SE	Description
1	Input
4	Output
2,3,5	Case Ground

### Ordering Information

Part No.	Description
885017	packaged part
885017-EVB	evaluation board

Standard T/R size = 10,000 units/reel.

## Specifications

### Electrical Specifications <sup>(1)</sup>

Specified Temperature Range: <sup>(2)</sup> -30 to + 85 °C (unless otherwise noted)

Parameter	Conditions	Min	Typical <sup>(3)</sup>	Max	Units
Center Frequency		-	2436	-	MHz
Maximum Insertion Loss	2400 - 2472 MHz @ 25 °C	-	1.8	2.5	dB
	2400 - 2472 MHz -30 to +85 °C	-	-	3.5	dB
	2401 - 2480 MHz -30 to +55 °C	-	2.5	3.5	dB
	2401 - 2480 MHz +55 to +85 °C	-	2.5	5.0	dB
	2480 - 2482 MHz <sup>(6)</sup> +25 °C	-	3.0	5.0	dB
Absolute Attenuation <sup>(4)</sup>	800 - 2000 MHz	22	25	-	dB
	2000 - 2300 MHz	24	26	-	dB
	2300 - 2360 MHz	25	36	-	dB
	2360 - 2370 MHz <sup>(6)</sup>	15	20	-	dB
	2370 - 2380 MHz <sup>(6)</sup>	5	8	-	dB
	2496 - 2502 MHz <sup>(7)</sup>	-	20	-	dB ave
	2500 - 2502 MHz	-	30	-	dB
	2500 - 2510 MHz <sup>(7)</sup>	-	45	-	dB ave
	2502 - 2690 MHz	25	30	-	dB
	2690 - 5000 MHz	25	28	-	dB
	7200 - 7416 MHz	-	14	-	dB
Amplitude Ripple	2400 - 2472 MHz (within any 18MHz Channel)	-	1.3	2.0	dB p-p
Input/output Return Loss	2400 - 2472MHz	6.0	10	-	dB
Source Impedance (single-ended) <sup>(5)</sup>		-	50	-	Ω
Load Impedance (single-ended) <sup>(5)</sup>		-	50	-	Ω

Notes:

- All specifications are based on the TriQuint schematic for the main reference design shown on page 3
- In production, devices will be tested at room temperature to a guardbanded specification to ensure electrical compliance over temperature
- Typical values are based on average measurements at room temperature
- Relative to zero dB
- This is the optimum impedance in order to achieve the performance shown
- These bands fall on the filter transitions, thus the typical attenuation/loss values given are prone to high variability
- Average attenuation level over the band

### Absolute Maximum Ratings

Parameter <sup>(8)</sup>	Rating
Operating Temperature	-30 to +85 °C
Storage Temperature	-40 to +85 °C
Input Power <sup>(9)</sup> (In passband, CW signal)	+28 dBm

- Operation of this device outside the parameter ranges given above may cause permanent damage.
- Represents the maximum allowable power level without electrical degradation equivalent to duration of 10,000 hours at 55°C

**Reference Design – 50Ω SE Input, 50Ω SE Output**

**Schematic (top view)**

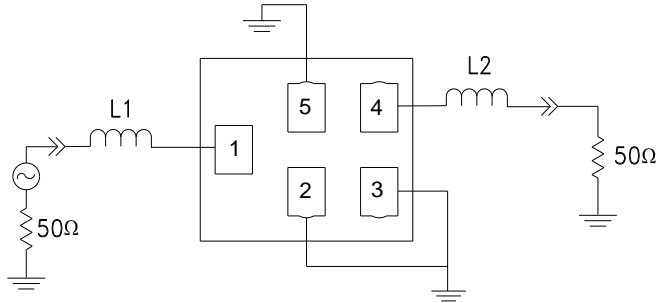

1. Notes:  
 Actual matching values may vary due to PCB layout and parasitic

**Pin Functions**

Pin #	Description
1	Input
4	Output
2,3,5	Ground

**PC Board**

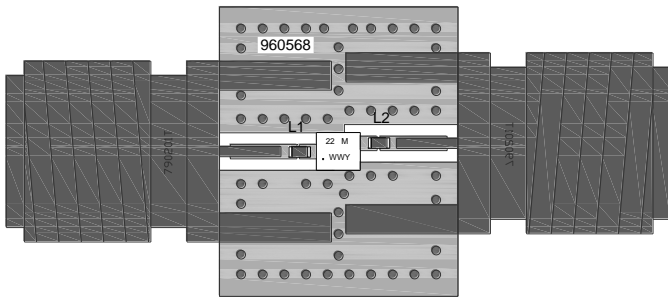

Notes:  
 Top, middle & bottom layers: 1 oz copper  
 Substrates: FR4 dielectric, .031” thick  
 Finish plating: Nickel: 3-8μm thick, Gold: .03-.2μm thick  
 Hole plating: Copper min .0008μm thick

**PCB routing detail**

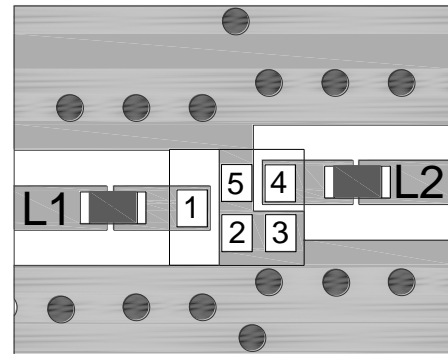

Notes:  
 1. Grey indicates metalized area  
 2. This footprint represents a recommendation only  
 3. For solder pad recommendation see mechanical information

**Bill of Material**

Reference Desg.	Value	Description	Manufacturer	Part Number
L1	1.5nH	Chip Inductor, 0402, +/- 0.2nH	MuRata	LQG15HN1N5S02
L2	1.5nH	Chip Inductor, 0402, +/- 0.2nH	MuRata	LQG15HN1N5S02
PCB	N/A	3-layer	multiple	960568

**Typical Performance** (at room temperature)

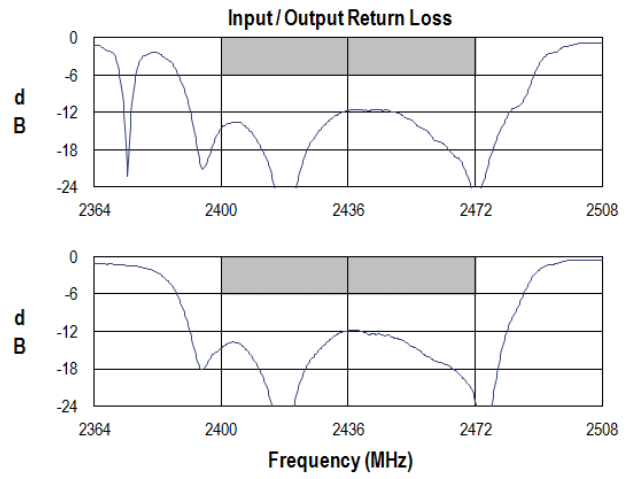
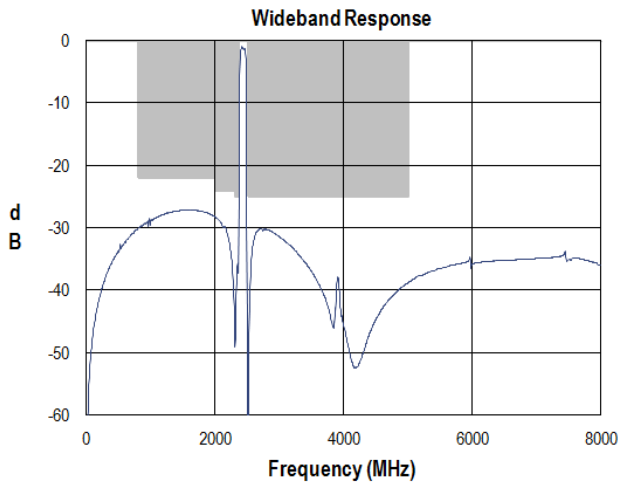
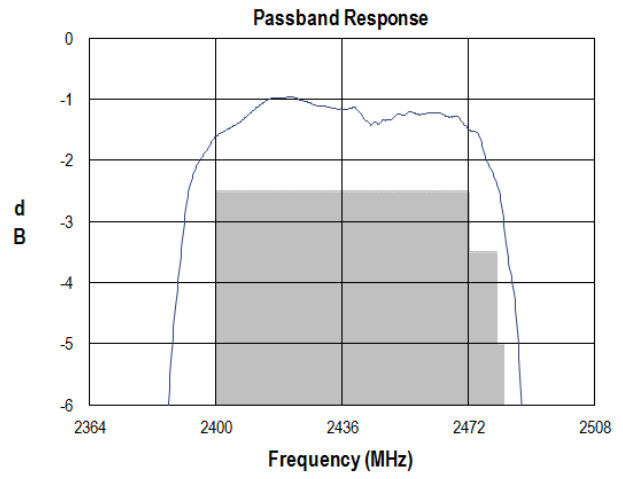
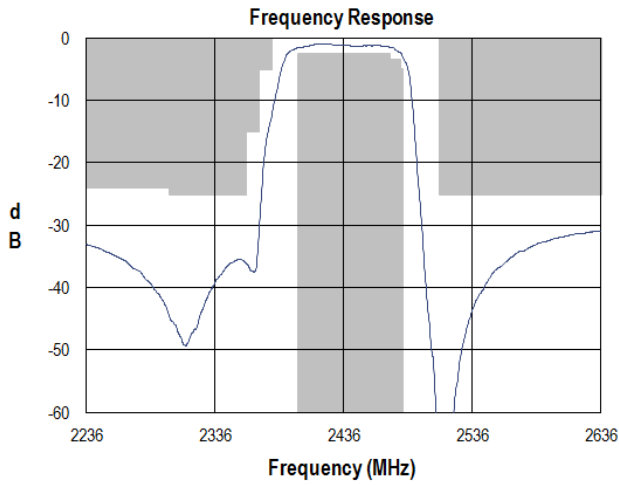

**Input Smith Chart**

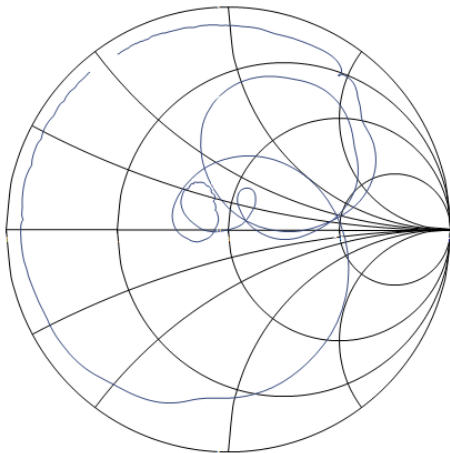

**Output Smith Chart**

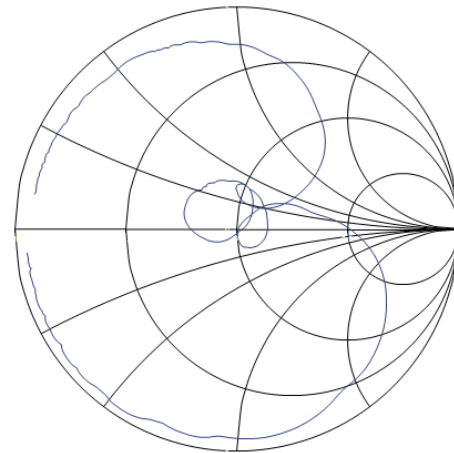

**Mechanical Information**

**Package Information, Dimensions and Marking**

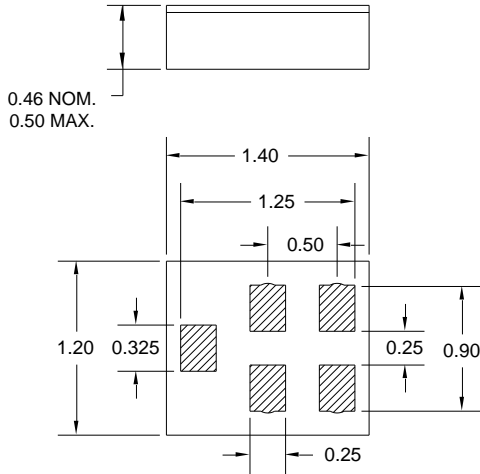

Package Style: CSP-5BT  
 Dimensions: 1.4 x 1.2 x 0.46 mm

Body:  $Al_2O_3$  ceramic  
 Lid: Kovar or Alloy 42, Au over Ni plated  
 Terminations: Au plating 0.5 - 1.0 $\mu$ m, over a 2-6 $\mu$ m Ni plating

All dimensions shown are nominal in millimeters  
 All tolerances are  $\pm 0.15$ mm except overall length and width  $\pm 0.10$ mm

**Marking**

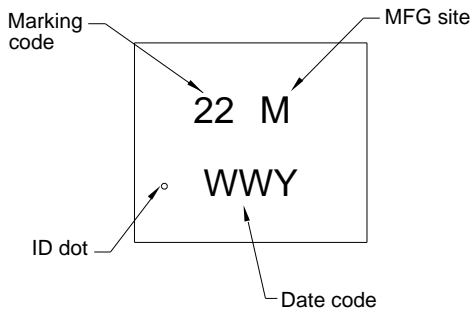

The date code consists of: WW = 2 digit week,  
 Y = last digit of year, M = manufacturing site code

**PCB Footprint**

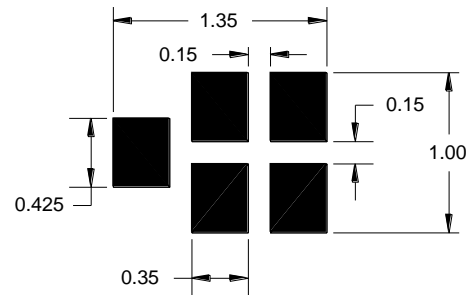

**Tape and Reel Information**

Standard T/R size = 10,000 units/reel. All dimensions are in millimeters

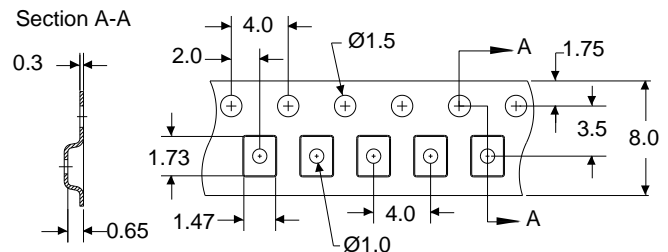
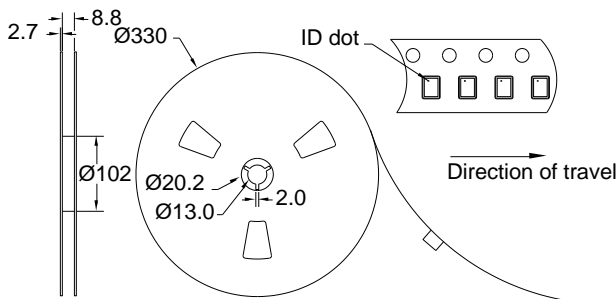

## Product Compliance Information

### ESD Information



#### Caution! ESD-Sensitive Device

ESD Rating: 1C

Value: Passes  $\geq 1600$  V min.  
Test: Human Body Model (HBM)  
Standard: JEDEC Standard JESD22-A114

ESD Rating: B

Value: Passes  $\geq 350$  V min.  
Test: Machine Model (MM)  
Standard: JEDEC Standard JESD22-A115

### MSL Rating

Devices are hermetic, therefore MSL is not applicable.

### Solderability

Compatible with the latest version of J-STD-020, lead free solder, 260°C

Refer to [Soldering Profile](#) for recommended guidelines.

This part is compliant with EU 2002/95/EC RoHS directive (Restrictions on the Use of Certain Hazardous Substances in Electrical and Electronic Equipment).

This product also has the following attributes:

- Halogen Free (Chlorine, Bromine)
- Antimony Free
- TBBP-A (C<sub>15</sub>H<sub>12</sub>Br<sub>4</sub>O<sub>2</sub>) Free
- PFOS Free
- SVHC Free

## Contact Information

For the latest specifications, additional product information, worldwide sales and distribution locations, and information about TriQuint:

Web: [www.triquint.com](http://www.triquint.com)  
Email: [info-sales@tqs.com](mailto:info-sales@tqs.com)

Tel: +1.407.886.8860  
Fax: +1.407.886.7061

For technical questions and application information:

Email: [flapplication.engineering@tqs.com](mailto:flapplication.engineering@tqs.com)

## Important Notice

The information contained herein is believed to be reliable. TriQuint makes no warranties regarding the information contained herein. TriQuint assumes no responsibility or liability whatsoever for any of the information contained herein. TriQuint assumes no responsibility or liability whatsoever for the use of the information contained herein. The information contained herein is provided "AS IS, WHERE IS" and with all faults, and the entire risk associated with such information is entirely with the user. All information contained herein is subject to change without notice. Customers should obtain and verify the latest relevant information before placing orders for TriQuint products. The information contained herein or any use of such information does not grant, explicitly or implicitly, to any party any patent rights, licenses, or any other intellectual property rights, whether with regard to such information itself or anything described by such information.

TriQuint products are not warranted or authorized for use as critical components in medical, life-saving, or life-sustaining applications, or other applications where a failure would reasonably be expected to cause severe personal injury or death.